

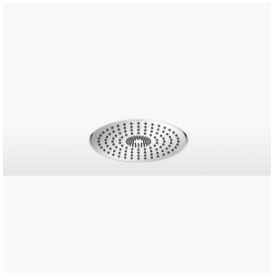













28 033 970



Fits: TARA, LISSÉ, VAIA, META

- rain shower Ø 300 mm
- PURE RAIN, max. flow rate 12 l/min (at 3 bar)
- PURIFY RAIN, max. flow rate 6 l/min (at 3 bar)
- min. recess depth 137 mm
- with anti-scale system
- For simultaneous control of the jet types, we recommend the xTool thermostat module
- Not suitable for use in a steam room.

	Chrome	28 033 970-00
	Brushed Platinum	28 033 970-06
	Platinum	28 033 970-08
	Dark Chrome	28 033 970-19
	Light Gold	28 033 970-26
	Brushed Light Gold	28 033 970-27
	Brushed Durabronze (23kt Gold)	28 033 970-28
	Matte Black	28 033 970-33
	Brushed Bronze	28 033 970-42
	Brushed Champagne (22kt Gold)	28 033 970-46
	Champagne (22kt Gold)	28 033 970-47
	Brushed Chrome	28 033 970-93
	Brushed Dark Platinum	28 033 970-99

### Required miscellaneous



**Concealed ceiling installation box 35 033 970 90  
for recessed ceiling installation -**

- recess depth 137mm
- 2x female thread 1/2" outlet
- concealed rough parts
- flush-mounted installation box Ø 360 mm RAL 9003 signal white

28 033 970

mm [inches]

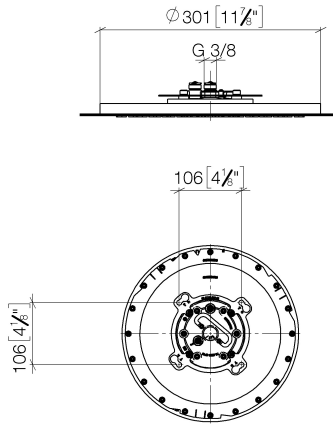

Flow rate chart

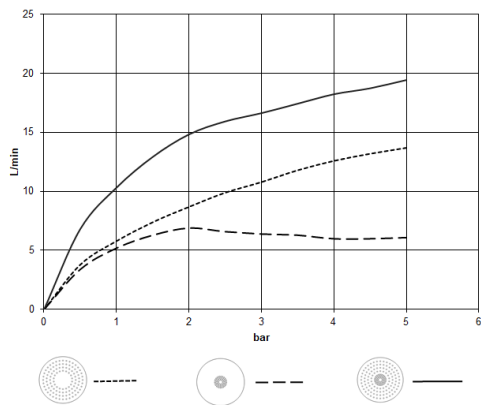

Certificates

LGA\_38402.

28 033 970

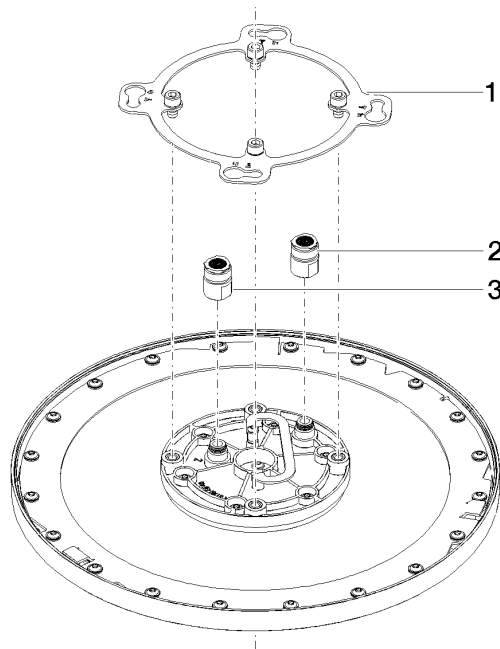

### Spare parts list

No.	Item Number	Name	Quantity used	Delivery time
1	90 17 20 262 00 90	flange	1	2
2	90 24 03 309 01 90	connection	1	2
3	90 24 03 309 00 90	connection	1	2